

Product Specification

Name: RGBW 4 channel controller

Model: NS-RF104



I. Summarization

RGBW 4 channel controller is a multifunction controller, mainly used for control 4 channel lamps, it supports switch the mode from RGBW to RGB+W, at the same time, under each large mode, it supports switch mode from 39 kinds small mode; This controller can control RGB and RGBW lamps, users no need to purchase a variety of controller, then can achieve the effect you want, also RGBW mode can realize pure white light effect that RGB lamps and lanterns can't reach.

II. Technical parameters

- Working temperature: -20-60℃
- Supply voltage: DC 12-24V
- Output voltage: DC 12-24V
- Output connect way: common anode (6 line with 4 loop)
- External dimension: L76.6*W59*H22.2 mm
- Packing size: L103*W70*H43 mm
- Net weight: 0.133kg
- Gross weight: 0.152kg
- Remote control static state current: <10uA
- Maximum output current : 4*4A
- Maximum output power: 192W/12V 384W/24V
- Remote control distance: <=25M

III. External Dimension

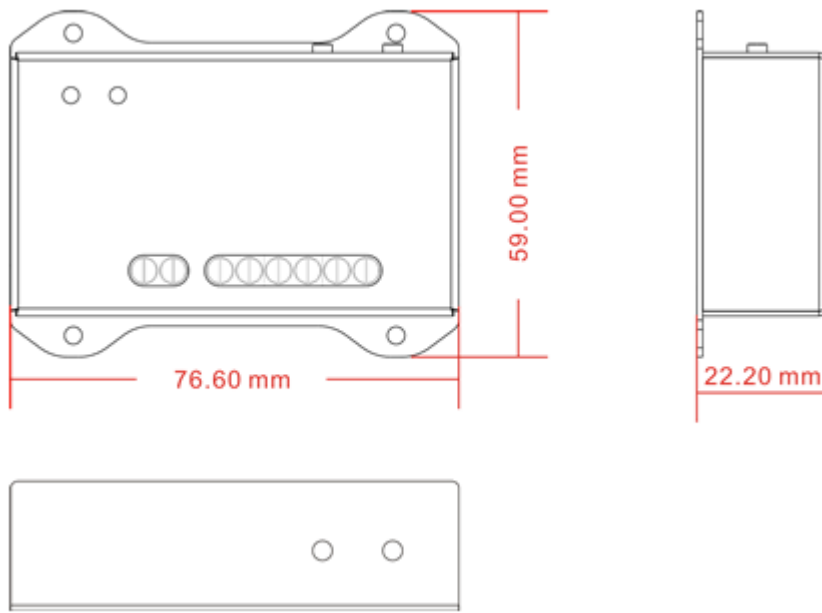

IV. Button function instruction

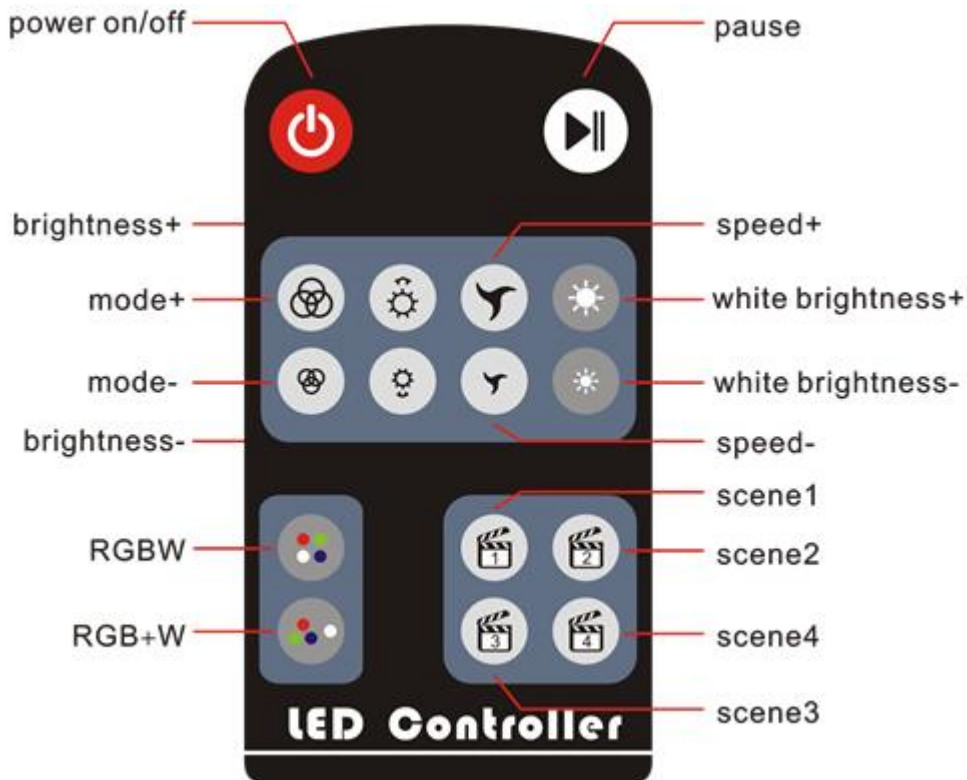

V. Product packing schematic diagram

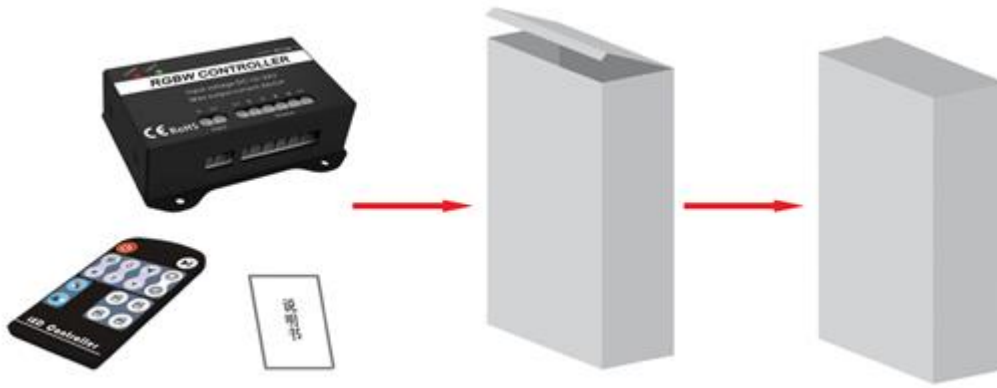

VI. Direction for use

1. Remote control instruction

This remote have 16 buttons. Unless specified, otherwise, signal light flashes for one time by each clicking. The specific keys function is as follows:



on/off key, you could turn on/off controller at any time;



Pause key. Under power on state, press the pause button, the controller will maintain the current state, the signal light will always bright, except the on/off key, all other buttons are invalid, until press the pause button again or on/off key to restart the controller to unlock the pause state, the signal light will off.



Mode increase key, the mode adds 1 by each pressing, mode table is shown in Table 1 and Table 2.



Mode reduce button, the mode minus 1 by each pressing. Mode table is as shown in Table1 or Table2.



Brightness increase button, in static mode, brightness series add 1 by each pressing, until up to the brightest, altogether 16 levels.



Brightness reduce button, in static mode, brightness series minus 1 by each pressing, until down to the darkest, altogether 16 levels.



Speed increase button, in dynamic mode, speed series add 1 by each pressing, until increase to the fastest, altogether 16 levels.





Speed reduce button, in dynamic mode, speed series minus 1 by each pressing, until reduce to the slowest, altogether 16 levels.





White light increase button, in RGB+W mode, brightness series of white light will add 1 by each pressing, until add to the brightest, altogether 16 levels.

 White light reduce button, in RGB+W mode, brightness series of white light will minus 1 by each pressing, until reduce to the darkest, altogether 16 levels.

 RGBW mode key, press this key, controller will be in the RGBW mode, in this mode, the fourth channel white light will instead of the white light of the RGB tricolor composite. As show in Table 1.

 RGB+W mode key, press this key, controller will be in the RGB+W mode, in this mode, the fourth channel white light and three channel RGB are independent, white light will be always on, and also you can adjust brightness separately, the specific mode is as shown in Table 2.

 Scene 1: you could save the current scene by long pressing the button, the green signal light will flash for six times quickly when save the scene successfully. Each button can save a scene respectively in RGBW and RGB+W mode.

 Scene 2: you could save the current scene by long pressing the button, the green signal light will flash for six times quickly when save the scene successfully. Each button can save a scene respectively in RGBW and RGB+W mode.

 Scene 3: you could save the current scene by long pressing the button, the green signal light will flash for six times quickly when save the scene successfully. Each button can save a scene respectively in RGBW and RGB+W mode.

 Scene 4: you could save the current scene by long pressing the button, the green signal light will flash for six times quickly when save the scene successfully. Each button can save a scene respectively in RGBW and RGB+W mode.

Table 1 RGBW Mode Table

Number	Mode	Number	Mode
1	Red	21	Red burst flashing
2	Orange	22	Green burst flashing
3	Deep-yellow	23	Blue burst flashing
4	Yellow	24	Yellow burst flashing
5	Light-yellow	25	White burst flashing
6	Green	26	Three-color burst flashing
7	Light green	27	Three-color flashing
8	Cyan	28	Three-color jumpy changing
9	Light-blue	29	Seven-color jumpy changing
10	Sky-blue	30	Red gradually fades
11	Blue	31	Yellow gradually fades
12	Deep-blue	32	Green gradually fades
13	Blue-purple	33	Cyan-blue gradually fades



14	Purple	34	Blue gradually fades
15	Brown	35	Purple gradually fades
16	White light	36	White gradually fades
17	Ivory	37	Three-color gradually fades
18	Pink-white	38	Seven-color gradually fades
19	Yellow-white	39	Seven-color gradual changing
20	Blue-white		

Table 2 RGB+W Mode Table

Number	Mode	Number	Mode
1	Red + White light	21	Red burst flashing + White light
2	Orange + White light	22	Green burst flashing + White light
3	Deep-yellow + White light	23	Blue burst flashing + White light
4	Yellow + White light	24	Yellow burst flashing + White light
5	Light-yellow + White light	25	White burst flashing + White light
6	Green + White light	26	Three-color burst flashing + White light
7	Light green + White light	27	Three-color flashing + White light
8	Cyan + White light	28	Three-color jumpy changing + White light
9	Light-blue + White light	29	Seven-color jumpy changing + White light
10	Sky-blue + White light	30	Red gradually fades + White light
11	Blue + White light	31	Yellow gradually fades + White light
12	Deep-blue + White light	32	Green gradually fades + White light
13	Blue-purple + White light	33	Cyan-blue gradually fades + White light
14	Purple + White light	34	Blue gradually fades + White light
15	Brown + White light	35	Purple gradually fades + White light
16	White light + White light	36	White gradually fades + White light
17	Ivory + White light	37	Three-color gradually fades + White light
18	Pink-white + White light	38	Seven-color gradually fades + White light
19	Yellow-white + White light	39	Seven-color gradual changing + White light
20	Blue-white + White light		

2. The instructions button operation on the controller

Match code key, controller is in normal power state, press and hold the key, at the same time press the on/off key for 3 seconds can match code, after matching code successfully, the signal light flashes for six times quickly.

The Function key, short press this key, the mode of controller adds 1, signal light flashes for one time. When the model is added to the last one, and then click it, the mode will be back to the first mode. Long press it for 3 seconds, can turn on/off the controller, signal light flashes for one time.

VII. Typical Applications

